

## Introduction

The ISL8105AEVAL1Z evaluation board highlights the operations of the ISL8105A controller in a DC/DC application. The evaluation board is configured for an output voltage of 1.8V and 15A maximum load.



FIGURE 1. ISL8105AEVAL1Z EVALUATION BOARD

## Power and Load Connections

### INPUT VOLTAGE

The evaluation board is optimized for an input supply of 12V, however, the input supply based on the connection can range from 4.5V to 5.5V or 6.5V to 14.4V.

The IC bias supply and the converter input voltage are connected together through R<sub>10</sub> to provide single rail power supply application.

### OUTPUT VOLTAGE LOADING AND MONITORING

Connect the positive lead of the electronic load and the positive lead of a digital multimeter to the V<sub>OUT</sub> terminal (J4) and the ground lead to the GND terminal (J5). The scope probe terminal (TPV01) can be used to monitor V<sub>OUT</sub> with an oscilloscope.

## Start-up

The ISL8105A starts up when V<sub>BIAS</sub> rises above POR threshold and the COMP/EN rises above V<sub>DISABLE</sub> level. The entire start-up time sequence from POR typically takes up to 17ms. There is fixed 6.8ms delay for the POR to initiate the Overcurrent Protection (OCP) sample and hold operation. The OCP sample and hold operation takes an additional 0ms to 3.4ms (the longer time occurs with the higher overcurrent setting). When the OCP sampling and hold operations are done, the soft-start function internally ramps the reference on the non-inverting terminal of the error amp from 0V to 0.6V in 6.8ms (typ).

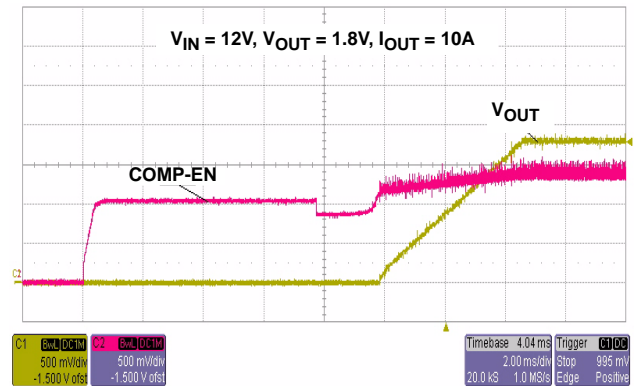

FIGURE 2. SOFT-START

Figure 1 shows the start-up profile of the ISL8105AEVAL1Z in relation to the start-up of the 12V input supply and the bias supply.

## Soft-Start with Pre-Biased Output

If the output is pre-biased to a voltage less than the expected value, the ISL8105A will detect that condition. Neither MOSFET will turn on until the soft-start ramp voltage exceeds the output; V<sub>OUT</sub> starts seamlessly ramping from there.

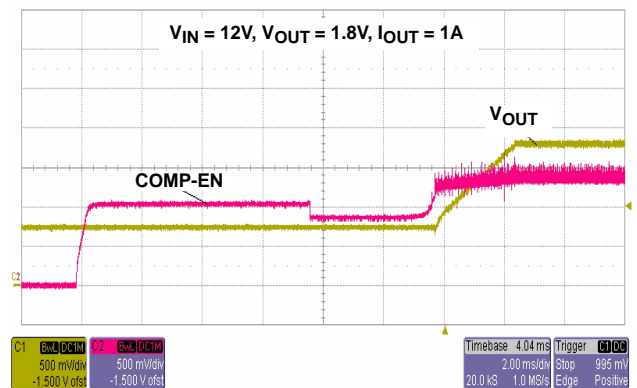

FIGURE 3. SOFT-START WITH PRE-BIASED OUTPUT

## Output Performance

### Switching Frequency

The evaluation board comes with a ISL8105A that has a fixed switching frequency of 600kHz.

### Output Ripple

Figure 4 shows the ripple voltage on the output of the regulator.

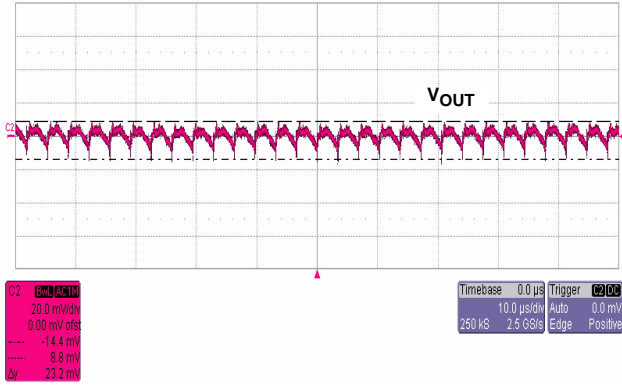

FIGURE 4. OUTPUT VOLTAGE RIPPLE (20MHz BW)

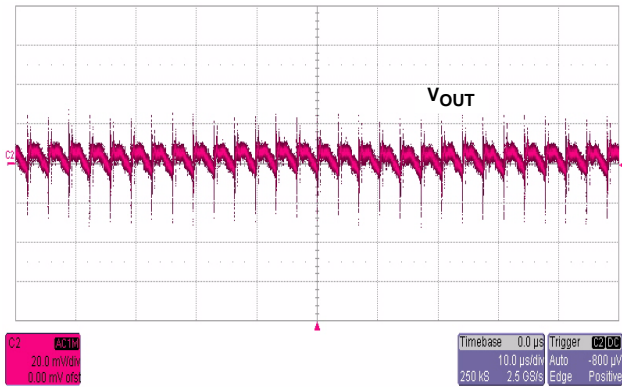

FIGURE 5. OUTPUT VOLTAGE RIPPLE AND NOISE (500MHz BW)

### Transient Performance

Figures 6, 7 and 8 show the response of the output when subjected to transient loading from 7.5A to 15A.

### Overcurrent Protection

The overcurrent function limits the output current by using the bottom-side MOSFET's  $r_{DS(ON)}$  to monitor the current. A resistor,  $R_{BSOC}$ , ( $R_G$ ) programs the overcurrent trip level. This method enhances the converter's efficiency and reduces cost by eliminating a current sensing resistor. If overcurrent is detected, the output immediately shuts off, it cycles the soft-start function in a hiccup mode (2 dummy soft-start time-outs, then up to one real one) to provide fault protection. If the shorted condition is not removed, this cycle will continue indefinitely. Figure 9 shows the overcurrent response and hiccup mode operation.

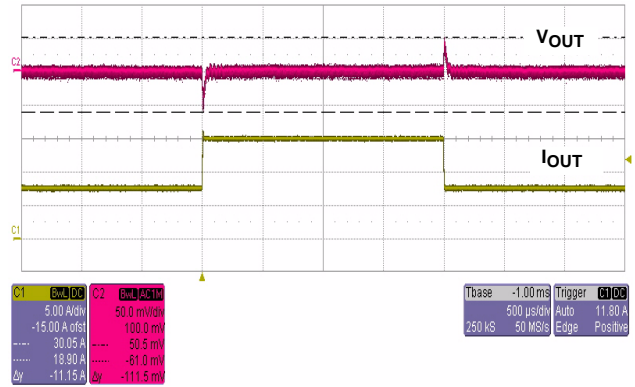

FIGURE 6. TRANSIENT RESPONSE

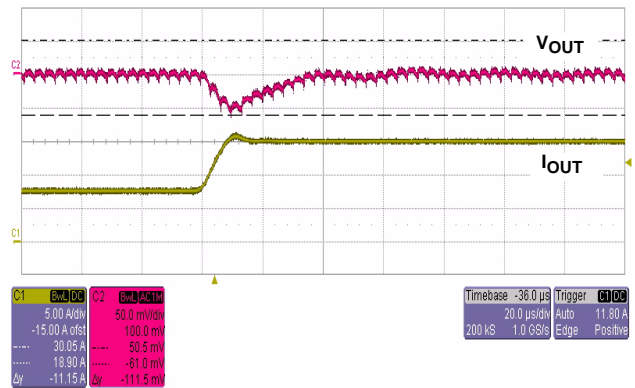

FIGURE 7. TRANSIENT RESPONSE

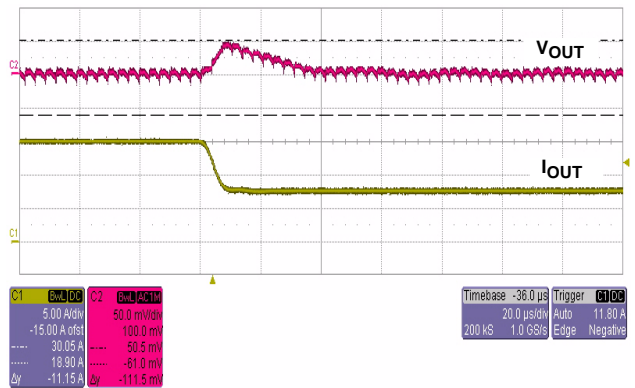

FIGURE 8. TRANSIENT RESPONSE

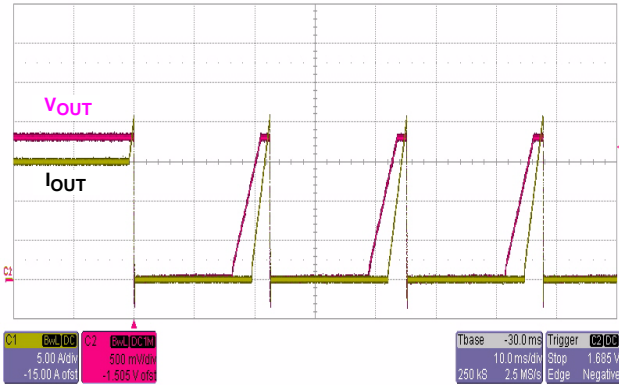

FIGURE 9. OVERCURRENT HICCUP MODE

The overcurrent function will trip at a peak inductor current ( $I_{PEAK}$ ) determined by Equation 1:

$$I_{PEAK} = \frac{2 \cdot I_{OCSET} \cdot R_{OCSET}}{r_{DS(ON)}} \quad (EQ. 1)$$

where  $I_{OCSET}$  is the internal  $21.5\mu A$  OCSET current source.

The OC trip point varies mainly due to the MOSFET's  $r_{DS(ON)}$  variations. To avoid overcurrent tripping in the normal operating load range, calculate the  $R_{OCSET}$  resistor from Equation 1 using:

1. The maximum  $r_{DS(ON)}$  at the highest junction temperature.
2. The minimum  $I_{OCSET}$  from the specification table.

Determine  $I_{PEAK}$  for  $I_{PEAK} > I_{OUT(MAX)} + (\Delta I)/2$

where  $\Delta I$  is the output inductor ripple current.

The overcurrent trip point on the evaluation board has been set to 19A for 5V<sub>BIAS</sub> (24A for 12V<sub>BIAS</sub>).

Figure 10 shows the output voltage recovers from overcurrent condition.

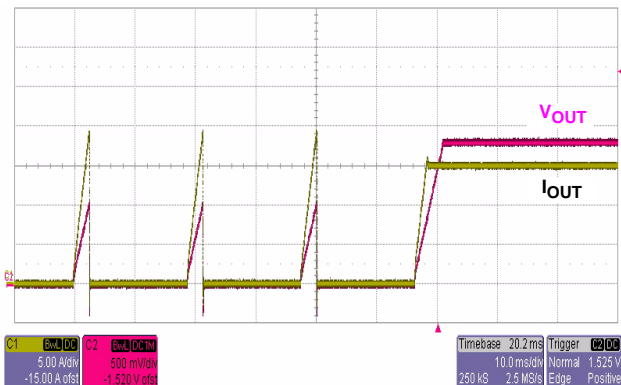

FIGURE 10. OVERCURRENT HICCUP MODE

### Efficiency

ISL8105A based regulators enable the design of highly efficient systems. The efficiency of the evaluation board using a 5V and a 12V input supply is shown in Figure 11.

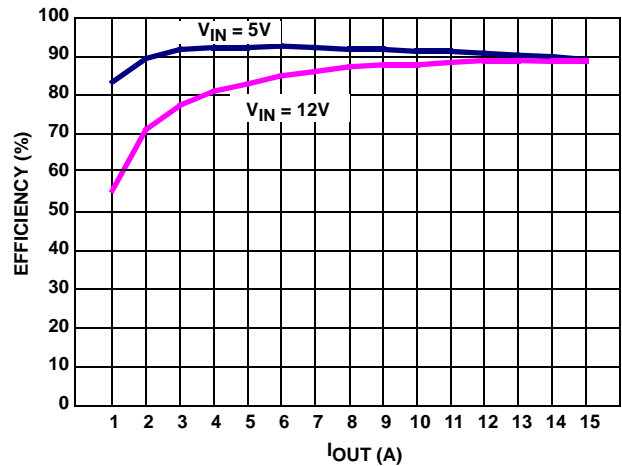

FIGURE 11. EVALUATION BOARD EFFICIENCY ( $V_{OUT} = 1.8V$ )

### References

For Intersil documents available on the web, see <http://www.intersil.com/>

- [1] ISL8105, ISL8105A Data Sheet, Intersil Corporation, FN6306

# ISL8105AEVAL1Z Schematic

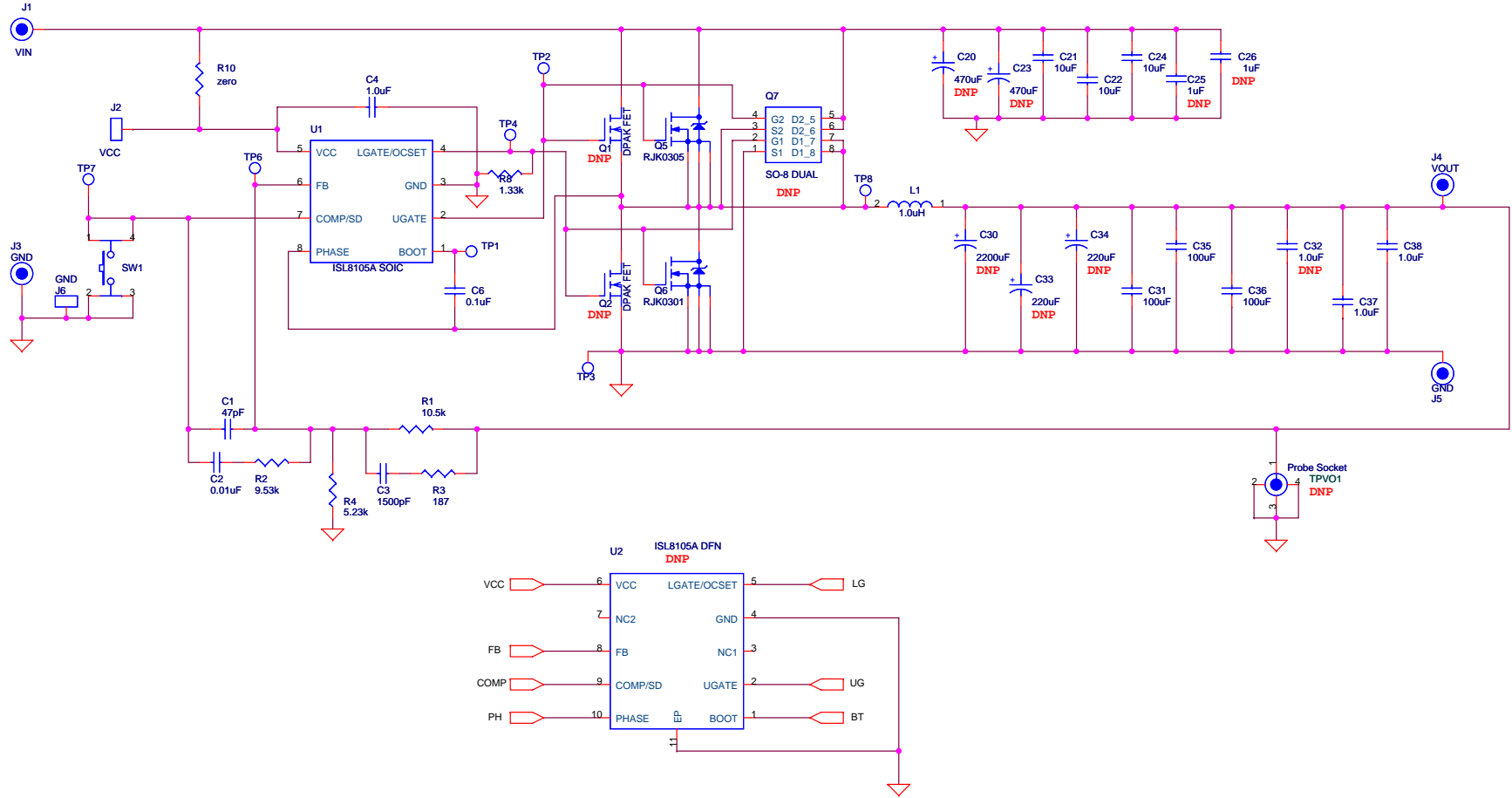

## Application Note 1258

### ISL8105AEVAL1Z Bill of Materials

| ID                | REFERENCE        | QTY | PART NUMBER             | PART TYPE               | DESCRIPTION                                   | PACKAGE     | VENDOR             |
|-------------------|------------------|-----|-------------------------|-------------------------|-----------------------------------------------|-------------|--------------------|
| 1                 | U1               | 1   | ISL8105AIBZ             | IC, Linear              | IC, Single PWM Controller                     | 8LD SOIC    | Intersil           |
| 2                 | U2               | DNP | ISL8105AIRZ             | IC, Linear              | IC, Single PWM Controller                     | 10LD DFN    | Intersil           |
| 3                 | Q1, Q2           | DNP |                         | MOSFET                  | N-Channel                                     | DPAK        |                    |
| 4                 | Q5               | 1   | RJK0305                 | MOSFET                  | N-Channel, 30V                                | LFPAK       | Renasas            |
| 5                 | Q6               | 1   | RJK0301                 | MOSFET                  | N-Channel, 30V                                | LFPAK       | Renasas            |
| 6                 | Q7               | DNP |                         | MOSFET                  | N-Channel, Dual                               | 8LD SOIC    |                    |
| 7                 | L1               | 1   | IHLP-5050FDER1R0M01     | Inductor                | 1.0μH, high current inductor                  | SMD         | Vishay             |
| 8                 | SW1              | 1   | EVQ-PAD04M              | Push Switch             | SWITCH-PUSH, TH, 6mm, 1P, PUSHB MOM-SPST      |             | PANASONIC          |
| <b>CAPACITORS</b> |                  |     |                         |                         |                                               |             |                    |
| 9                 | C1               | 1   |                         | Capacitor, Ceramic, X7R | 47pF, 50V, 5%, NPO, ROHS                      | SM_0603     | TDK/Generic        |
| 10                | C2               | 1   |                         | Capacitor, Ceramic, X7R | 0.01μF, 50V, 10%, ROHS                        | SM_0603     | TDK/Generic        |
| 11                | C3               | 1   |                         | Capacitor, Ceramic, X7R | 1500pF, 50V, 10%, ROHS                        | SM_0603     | TDK/Generic        |
| 12                | C4               | 1   |                         | Capacitor, Ceramic, X7R | 1μF, 16V, 10%, X7R, ROHS                      | SM_0603     | TDK/Generic        |
| 13                | C6               | 1   |                         | Capacitor, Ceramic, X7R | 0.1μF, 16V, 10%, ROHS                         | SM_0603     | TDK/Generic        |
| 14                | C20, C23         | DNP | 16MCZ470M8X11.5         | Capacitor, Alum. Elec   | 470μF, 16V, 20%, 21mΩ, Pb-free                | RADIAL 8x11 | RUBYCON            |
| 15                | C21, C22, C24    | 3   |                         | Capacitor, Ceramic, X5R | 10μF, 16V, 10%, ROHS                          | SM_1210     | TDK/Generic        |
| 16                | C25, C26         | DNP |                         | Capacitor, Ceramic, X5R | 1μF, 6.3V, 20%, ROHS                          | SM_1812     | TDK/Generic        |
| 17                | C30, C33, C34    | DNP | 6.3MCZ1200M8X16         | Capacitor, Alum. Elec   | 1200μF, 6.3V, 20%, 18mΩ, Pb-free              | RADIAL 8x16 | RUBYCON            |
| 18                | C31, C35, C36    | 3   |                         | Capacitor, Ceramic, X5R | 100μF, 6.3V, 20%, ROHS                        | SM_1812     | TDK/Generic        |
| 19                | C32              | DNP |                         | Capacitor, Ceramic, X5R | 1μF, 6.3V, 10%, ROHS                          | SM_0603     | TDK/Generic        |
| 20                | C37, C38         | 2   |                         | Capacitor, Ceramic, X5R | 1μF, 6.3V, 10%, ROHS                          | SM_0603     | TDK/Generic        |
| <b>RESISTORS</b>  |                  |     |                         |                         |                                               |             |                    |
| 21                | R1               | 1   |                         | Resistor, Film          | 10.5kΩ, 1%, 1/16W                             | SM_0603     | Panasonic/Generic  |
| 22                | R2               | 1   |                         | Resistor, Film          | 9.53kΩ, 1%, 1/16W                             | SM_0603     | Panasonic/Generic  |
| 23                | R3               | 1   |                         | Resistor, Film          | 187Ω, 1%, 1/16W                               | SM_0603     | Panasonic/Generic  |
| 24                | R4               | 1   |                         | Resistor, Film          | 5.23kΩ, 1%, 1/16W                             | SM_0603     | Panasonic/Generic  |
| 25                | R8               | 1   |                         | Resistor, Film          | 1.33kΩ, 1%, 1/16W                             | SM_0603     | Panasonic/Generic  |
| 26                | R10              | 1   | RC0805JR-070RL          | Resistor, Film          | 1/8W, TF, ROHS                                | SM_0805     | YAGEO              |
| <b>OTHERS</b>     |                  |     |                         |                         |                                               |             |                    |
| 27                | TPVO1            | DNP | 0293-0-15-15-16-27-10-0 | Terminal, Scope Probe   | CONN-PIN RECEPTACLE, 0.086 DIA, 0.200 L, ROHS |             | MILL-MAX           |
| 28                | J1, J3, J4, J5   | 4   | 111-0702-001            | Banana Connector        | CONN-GEN, BIND. POST, THMBNUT-GND             |             | JOHNSON COMPONENTS |
| 29                | J2, J6           | 2   | 1514-2                  | Turret Post             | CONN-TURRET, TERMINAL POST, TH, ROHS          |             | Keystone           |
| 30                | TP1-TP4, TP6-TP8 | DNP | 5002                    | Test Point              | CONN-MINI TEST POINT, VERTICAL, WHITE, ROHS   |             | Keystone           |

ISL8105AEVAL1Z Printed Circuit Board Layers

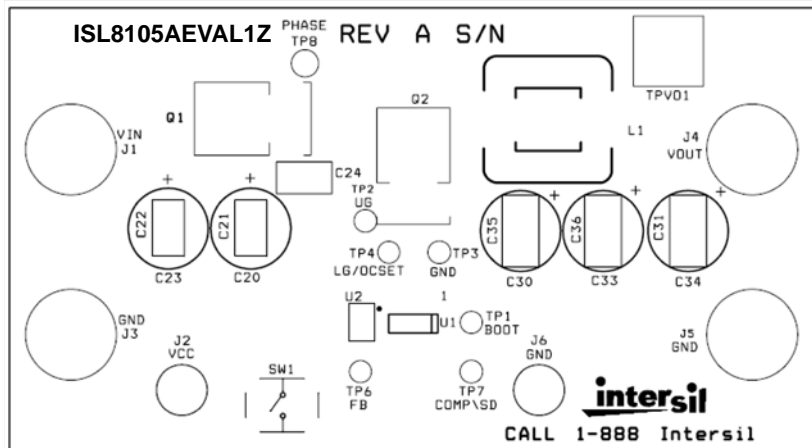

FIGURE 12. ISL8105AEVAL1Z - TOP LAYER (SILKSCREEN)

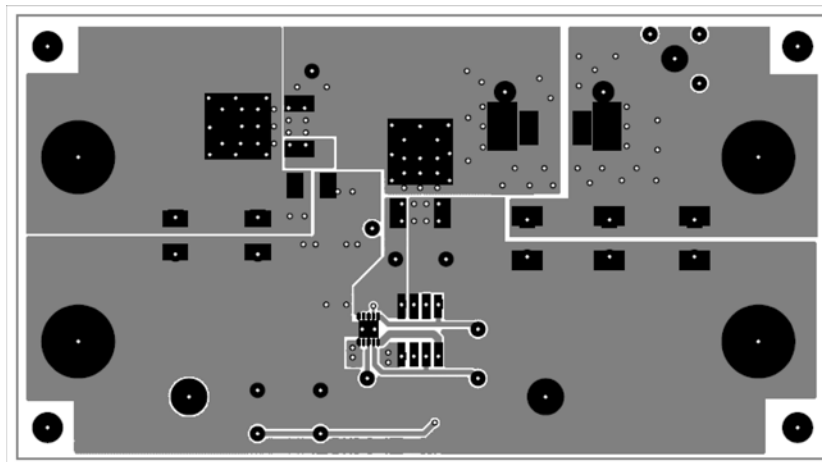

FIGURE 13. ISL8105AEVAL1Z - TOP LAYER (COMPONENT SIDE)

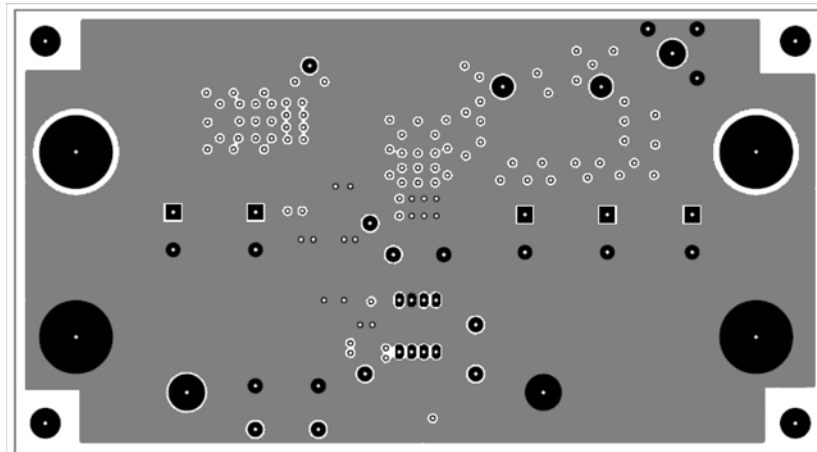

FIGURE 14. ISL8105AEVAL1Z - LAYER 2

ISL8105AEVAL1Z Printed Circuit Board Layers (Continued)

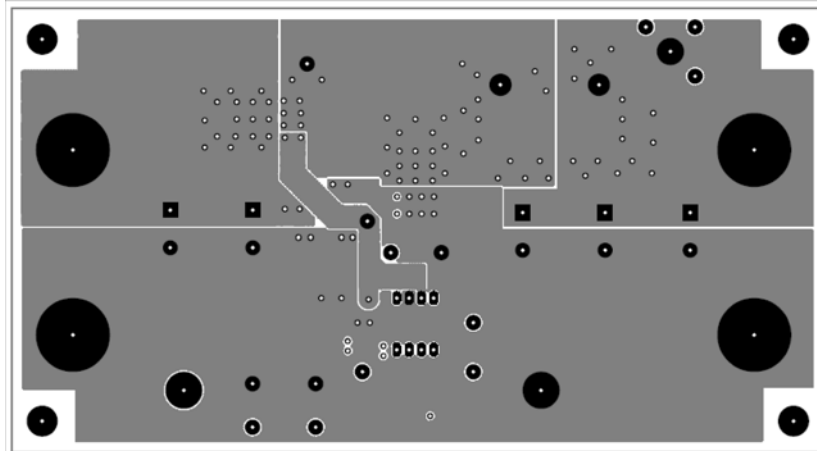

FIGURE 15. ISL8105AEVAL1Z - LAYER 3

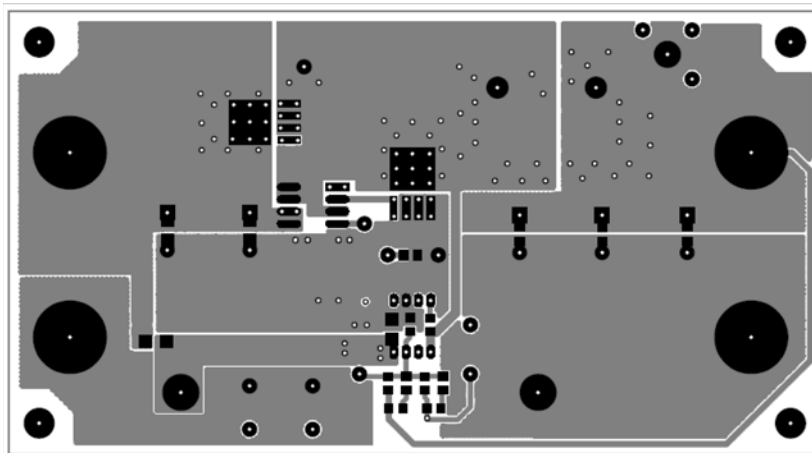

FIGURE 16. ISL8105AEVAL1Z - LAYER 4

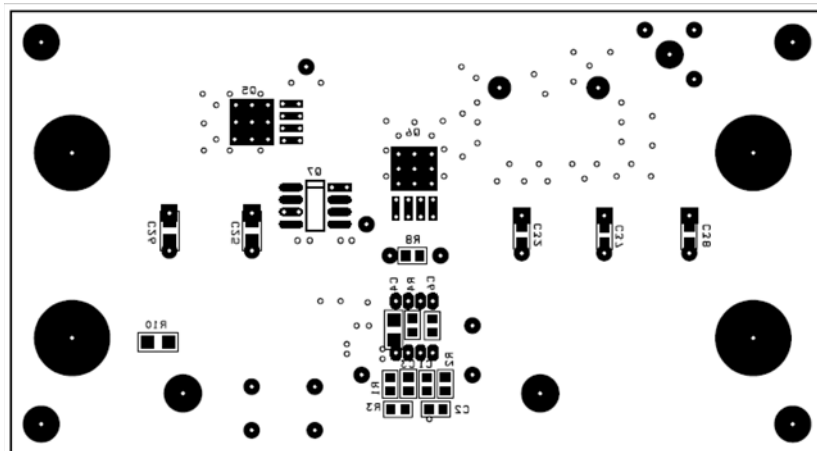

FIGURE 17. ISL8105AEVAL1Z - BOTTOM LAYER (SOLDER SIDE)

Intersil Corporation reserves the right to make changes in circuit design, software and/or specifications at any time without notice. Accordingly, the reader is cautioned to verify that the Application Note or Technical Brief is current before proceeding.

For information regarding Intersil Corporation and its products, see [www.intersil.com](http://www.intersil.com)